



The magnetic connector that changes your lighting design.

MAG-Y is the heart of Creative Cables' new modular series. A metal element with a magnetic core, designed to be combined with extensions and cables, offering total freedom in customising any lighting system.

MAG-Y



creative
cables



The MAG-Y component, a little bit MAGnetic and a little bit MAGic allows you to design the lamp that you desire. **With MAG-Y you are the designer, the artist, the creator!**

MAG-Y

The minimalist design of the MAG-Y recalls the silhouette of a 'Y', but its real magic is in how it works. Thanks to its internal magnet, lamps can be placed on any metal surface or mounted on the wall using a special metal washer, offering complete freedom in lighting design.



MAG-Y MAGNETIC SUPPORT KIT

A basic component to create any lamp of the same name, MAG-Y owes its name to the magnetic heart with its distinctive Y shape. Designed to go with most of Creative Cables' extensions and cables, this holder is a simple starting point that allows you to compose the table, floor or wall lamp that best suits your environment.

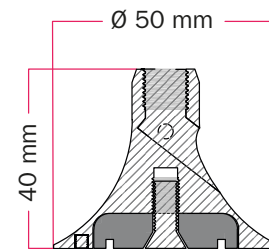

MAG-Y, magnetic support kit

Material: **Metal**
Thread: **M10x1**
Max cable diameter: **20 mm**

CE
UK
CA

Finish

Code

● Matt White	MAGSUPPORTVBO
● Matt Black	MAGSUPPORTVN
● Brushed Titanium	MAGSUPPORTTIS
● Brushed Bronze	MAGSUPPORTOTS
● Brushed Copper	MAGSUPPORTRAS

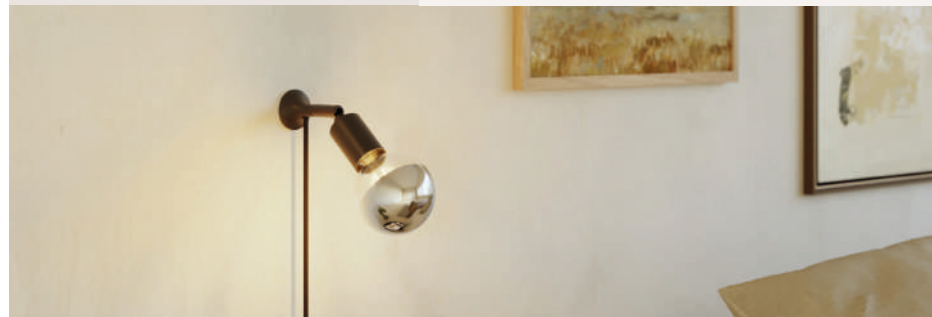

THE FREEDOM TO DESIGN WITHOUT LIMITS.

Assemble, attach, and illuminate— with a simple gesture, light shifts and adapts to your needs. Thanks to its internal magnet, it easily connects to bases, extensions, and cables, ensuring stability and limitless creative possibilities.

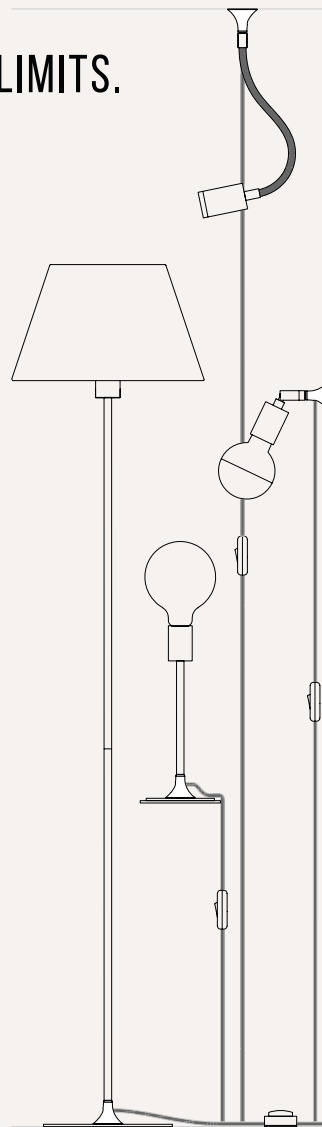
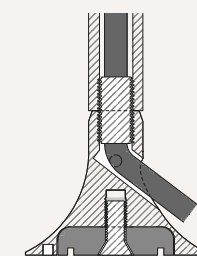
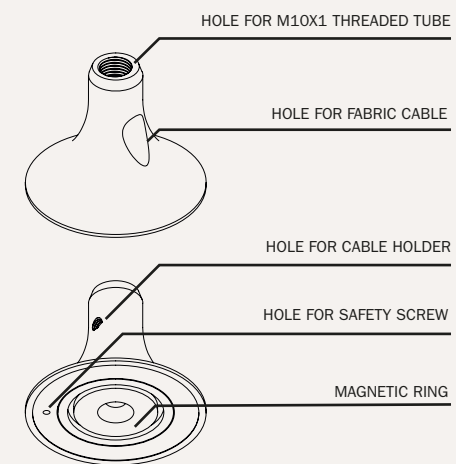

MAG-Y TABLE LAMP BASES

The base of the MAG-Y series is the metal accessory needed to create a table lamp, giving stability and style to the magnetic kit of the same series. A decorative element designed for bookcases, coffee tables and desks, it is available in different shapes and finishes to best suit any style or environment.



Round metal base for MAG-Y table

Material: **Metal** CE
UK
CA
 Thickness: **4 mm**
 Diameter: **120 mm**
 Scratch-resistant protective pad

Finish	Code
● Matt White	BASETAVOLO1VBO
● Matt Black	BASETAVOLO1VN
● Brushed Titanium	BASETAVOLO1TIS
● Brushed Bronze	BASETAVOLO1OTS
● Brushed Copper	BASETAVOLO1RAS



Oval metal base for MAG-Y table lamp

Material: **Metal** CE
UK
CA
 Thickness: **4 mm**
 Dimensions: **130 mm x 90 mm**
 Scratch-resistant protective pad

Finish	Code
● Matt White	BASETAVOLO2VBO
● Matt Black	BASETAVOLO2VN
● Brushed Titanium	BASETAVOLO2TIS
● Brushed Bronze	BASETAVOLO2OTS
● Brushed Copper	BASETAVOLO2RAS



MAG-Y WALL DISK

The MAG-Y metal wall disc is the Creative Cables accessory that allows you to attach the magnetic kit from the same series to any non-ferrous surface.



Metal wall disc MAG-Y

Material: **Metal** CE
UK
CA
 Thickness: **0.3 mm**
 Diameter: **50 mm**
 Scratch-resistant protective pad

Finish	Code
● Matt White	BASEPARETEVBO



MAG-Y FLOOR LAMP ACCESSORIES

To create floor lamps in the MAG-Y series, we have designed a dedicated extension and a custom floor base. These components allow for maximum stability and versatility, giving you the freedom to position your lamp exactly where you need it.

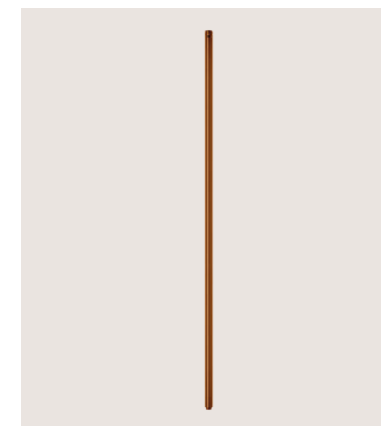

Metal extension tube for MAG-Y floor lamps

Material: **Metal** CE
UK
CA
 Length: **600 mm**
 Inner diameter: **9 mm (M10x1 thread at each end)**

Finish	Code
● Matt White	EXT60VBO
● Matt Black	EXT60VN
● Brushed Bronze	EXT60OTS



Round metal base for MAG-Y floor lamp

Material: **Metal** CE
UK
CA
 Thickness: **4 mm**
 Diameter: **220 mm**

Finish	Code
● Matt White	BASETERRA1VBO
● Matt Black	BASETERRA1VN
● Brushed Bronze	BASETERRA1OTS

